



Power-Light Emitting Diode 大功率发光二极管

Part NO.:P1WLRLAR1 (产品型号)

Features:

Package Dimension:

Lens Color(胶体颜色): Water Clear(透明)

Source Color(发光颜色): Red (红色)

Bright BIN(亮度等级): Ultra Bright(超高亮)

LED Chips: OSRAM

Absolute Maximum Ratings at Ta=25°C

Electrical Optical Characteristics at Ta=25°C

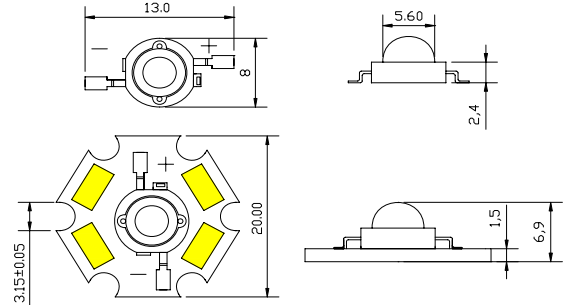

Parameter	Symbol	Rating	Units
DC Forward Current	I_F	350	mA
Reverse Voltage	V_R	5	V
LED junction Temperature (at 350 mA)	T_j	125	°C
Operating Temperature	T_{opr}	-30 ~ +110	°C
Storage Temperature	T_{stg}	-40 ~ +120	°C
Manual Soldering Time at 260°C (MAX.)	T_{sol}	5	Seconds
Make use of life	Hr	100000	H

Parameter	Symbol	condition	Min.	Typ.	Max.	Unit
Give out light the power	P	IF=350mA	---	1	---	W
Luminous Flux	Flux	IF=350mA	40	---	50	lm
Thermal Resistance Junction to Board	$R \theta_{J-B}$	IF=350mA	---	15	---	°C/W
Viewing Angle(发光角度)	$2\theta_{1/2}$	IF=350mA	---	120		Deg
Spectral Line Half-Width(波长频率)	$\Delta \lambda$	IF=350mA	620	---	630	nm
Temperature Coefficient Of Forward Voltage	$\Delta V_F / \Delta T$	IF=350mA	---	-2	---	mV/°C
Forward Voltage	V_F	IF=350mA	2.4	---	2.6	V
Reverse Current	I_R	VR=-5V	---	---	10	μA